



Installation Manual for Springfree O92 Trampoline



Installing the tgoma can be challenging if you don't carefully follow these instructions. To make it easier, we have demonstration videos that will guide you through each step. Visit www.tgoma.com/support to get started.

Your Product Serial Number is:

|
—

The information in this document is subject to change without notice.

© Copyright tgoma NZ Ltd., 2016. All rights reserved.

729802



WARNING

Please read the Installation Manual before using your tgoma® game system and keep it for future reference.



Treat any loaded rod with caution until you are sure it is properly installed or uninstalled. Keep face clear of loaded rods. An improperly installed rod could release and cause facial injury or blindness.



Never attempt to remove a black net rod from its net pocket or disengage (unlock) the rod sleeve while the black net rod is under tension.



Do not hold onto, or place fingers between the rods while someone is jumping on the trampoline.



The trampoline and tgoma game system are not intended for children under 6 years of age as certain parts could represent a choking or entrapment hazard.



This game system should be disposed of separately from household waste and according to local laws. When disposing of this equipment, please take it to a designated collection point. Incorrect disposal of items can be hazardous to the environment. Many items can be recycled. Follow all local regulations for any disposal. Packaging elements of this product have been labelled to assist your choice of recycling options. In particular, always dispose of the (user supplied) batteries in full accord with the battery manufacturer's instructions.



This game system uses sensors to detect your position on the trampoline mat. They read most accurately when the trampoline is installed on a flat, level surface. If your trampoline is installed on a surface that is more than 100mm out of level from one side of the trampoline to another, we recommend that you level the trampoline.



Assembly and disassembly of the trampoline in any way other than what is set out in these instructions could cause serious injury or damage the trampoline.



In regions where there is an accumulation of snow and ice and/or temperatures drop below 14 degrees Fahrenheit (-10 degrees Celsius), we recommend the removal of the controller from the trampoline. The cables do not need to be removed, however, please ensure that the plugs at the end of the cables are tightly sealed in plastic (e.g. inside a plastic bag) and positioned in such a way that no moisture can enter.



The controller and battery pack attach with powerful magnets. Keep away from electronic devices and magnetic strips to avoid damaging effects.





WARNING

Please read the Installation Manual before using your tgoma® game system and keep it for future reference.

- A. Please read the following precautions carefully before you assemble and use the trampoline, enclosure, and tgoma game system.
- B. Check all trampoline components for wear or damage prior to reassembly and use.
- C. Keep small children at least 25 ft (7.5 m) away while assembling or disassembling the trampoline; they could be injured by improperly assembled rods releasing and ejecting from the frame.
- D. Be aware that when loaded, the rods can spring back and may cause injury.
- E. Treat any loaded rod with caution until you are sure it is properly uninstalled. In particular, keep your face well clear of the rods during assembly or disassembly. An improperly installed rod could release and cause facial injury or blindness.
- F. No somersaults or flips. Landing on the head or neck can cause serious injury, paralysis, or death, even when landing in the middle of the bed.
- G. No more than one person at a time. Multiple jumpers increase the chances of loss of control and collision and can result in serious head, neck, back, leg, arm or other injuries.
- H. Use only with mature, knowledgeable supervision. Enforce all safety rules.
 - I. Do not exceed the maximum user weight.
- J. The trampoline and tgoma game system is not intended for children under 6 years of age as entrapment hazards may result.
- K. The cable attachment system utilizes small plastic cable clips. When not installed, keep out of reach of small children as they could represent a choking hazard.
- L. The tgoma game system contains small magnets. Swallowed magnets can stick to intestines causing serious injury or death. Seek immediate medical attention if magnets are swallowed or inhaled.
- M. Ensure adequate supervision of children while inserting and removing the tablet from the tablet clamp. tgoma takes no responsibility for damages to portable electronic devices resulting from incorrect use or negligence.
- N. Trampolines and portable electronic devices were intended for separate purposes. Take extra precautions while jumping on the trampoline with a tgoma game system installed as it may interfere with or cause the jumper to fall awkwardly.
- O. Do not use the mat/bed when it is wet. Do not use the tgoma game system in rainy or wet conditions. The tablet holder is water resistant, however, it is not designed to provide a completely waterproof shade for the tablet. Do not leave your portable electronic device outside in wet weather.
- P. During play with the tgoma game system, keep players face away from the tablet holder. Serious injury can occur if teeth/face come in contact with the tablet or tablet holder.
- Q. When not using the tgoma game system, remove the tablet holder from the enclosure as it represents a potential impact point.
- R. Do not use the trampoline as a springboard to other objects. Use the trampoline only for trampoline style bouncing.
- S. Ensure the enclosure system is attached and in good condition before use.
- T. Inspect trampoline enclosure and tgoma game system prior to each use and replace any worn or damaged parts. Take extra precaution to ensure that the cable ties that hold the sensor top plates are not damaged. Replace any that appear worn or damaged. The sensor top plates contain small prongs that could puncture the skin if they disengage from the sensor mount as a result of a worn or damaged cable tie.
- U. Enclosure systems are designed to prevent users falling off the trampoline. Do not allow users to intentionally bounce towards or off the barrier, as this can unbalance the trampoline and continual impact may damage the enclosure. Do not hang, kick, cut or climb on the enclosure or tgoma game system. Do not attempt to jump over the enclosure.
- V. Wear comfortable clothing that won't become entangled in the trampoline's components and become a strangulation hazard. Do not wear jewelry or drawstrings/cords that can catch on the trampoline or the tgoma game system and create a strangulation hazard. Remove shoes as they may damage the bed and increase the risk of injury.
- W. Avoid jumping too high or for too long. Always control your jump.
- X. Please read and ensure your trampoline complies to the Installation and Placement instructions in your trampoline User Guide.
- Y. Only for domestic use.
- Z. tgoma game system is intended for indoor and outdoor usage.

1

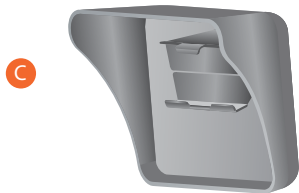

D

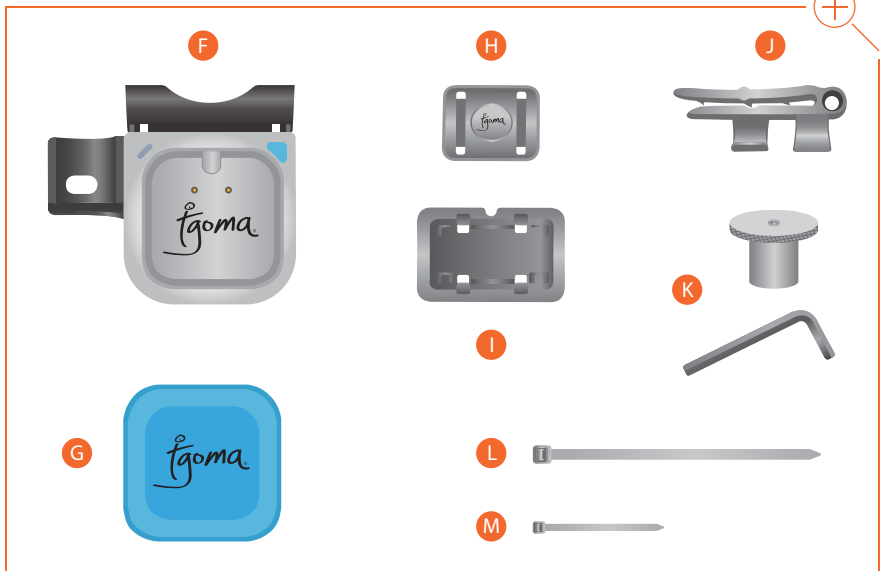
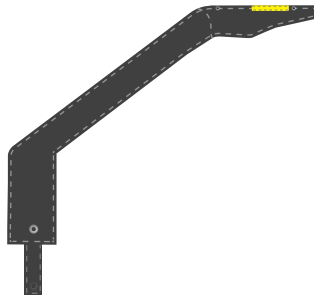

E

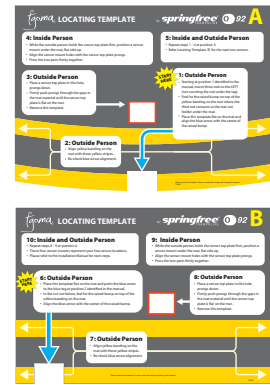

Part	Description	Part	Description		
A	Tablet Holder Rods	1	H	Sensor Top Plate	4
B	Sensor Cables	2	I	Sensor Mount	4
C	Tablet Holder	1	J	Cable Clips	42
D	Sensor Cable Tube	1	K	Nut and Hex Key	1
E	Locating Template	2	L	Large Cable Ties	2
F	Controller	1	M	Small Cable Ties	10
G	Battery Pack	1	N	Spare Small Cable Ties and Cable Clips	8+4



NOTE - TWO people are required for assembly.
NOTE - Installation typically takes ONE hour to complete.

- Layout all parts listed as shown.

OUTSIDE VIEW

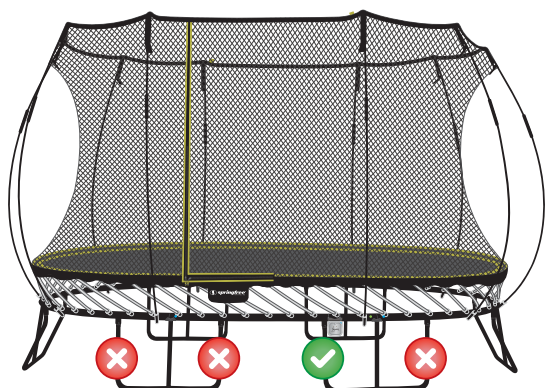

INSIDE VIEW

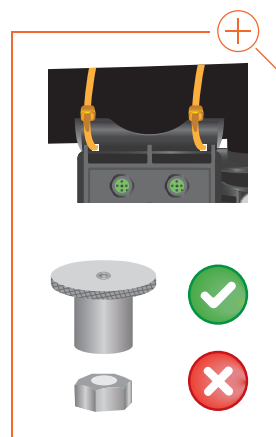
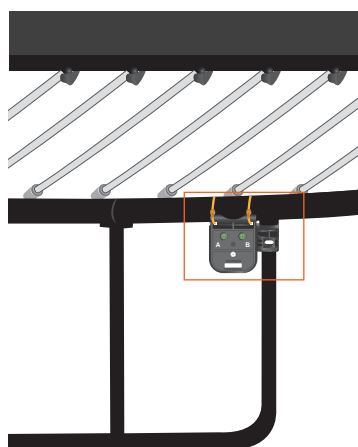

NOTE - Have one person position themselves under the trampoline (hereafter known as the Inside Person) while the other person works around the outside of the trampoline (Outside Person).

NOTE - Be sure to position the controller at the correct leg position, as indicated. If installed in the wrong location, you will be unable to complete the following steps correctly.

- **Inside Person:** Locate the nut on the back of the leg shown above. Remove the nut but DO NOT remove the bolt.
- **Inside Person:** Position the controller as shown and fasten with the new nut provided. Tighten with the hex key.
- **Inside Person:** Feed a large cable tie through each of the two holes and around the frame. Rotate the head of the cable tie so that it is not visible from outside the trampoline, then fasten.



WARNING - Do not remove the bolt from the leg as this could cause serious injury.

WARNING - Do not over tighten the nut. Do not use power driver, torque wrench, or drill.



TIP - Throughout this manual, certain images contain parts that have been colored orange. This is meant to bring specific attention to a particular installation step and is not a representation of their actual color.

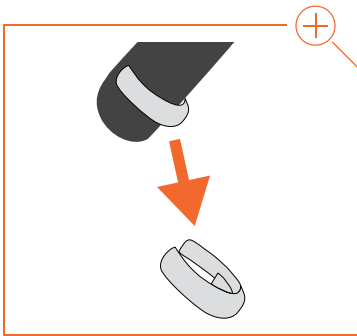
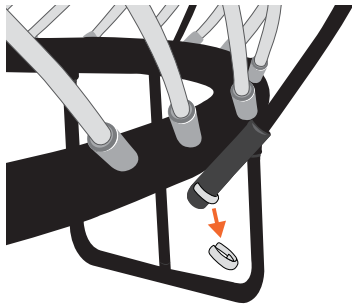

OUTSIDE VIEW

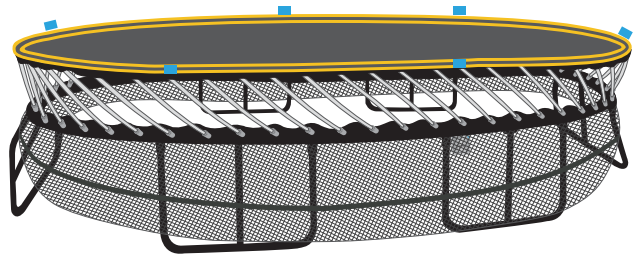
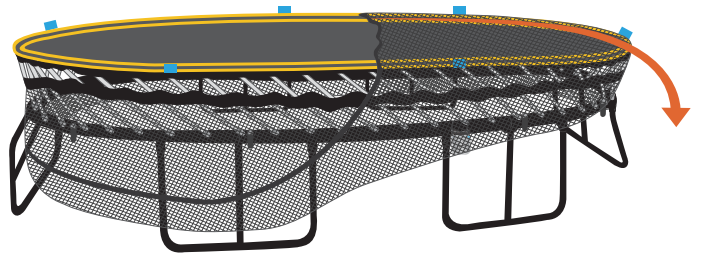

WARNING - Treat any loaded rod with caution until you are sure it is properly installed or uninstalled. Keep your face well away from any loaded rod.

WARNING - Do not use the trampoline unless it is completely assembled. Failure to follow these instructions may cause rods to break or eject from the trampoline frame.

- **Outside Person:** Remove the white c-clips located on the net rod sockets. Lift the bottom end of the black net rods out of the net rod sockets and lower the net.
- **Outside Person:** Remove the black net rods from the net rod pockets.
- **Outside Person:** Starting at a corner, carefully pull the top edge of the net down over the edge of the mat. Continue around the trampoline until the net is sitting at the bottom of the mat rods.

OUTSIDE VIEW

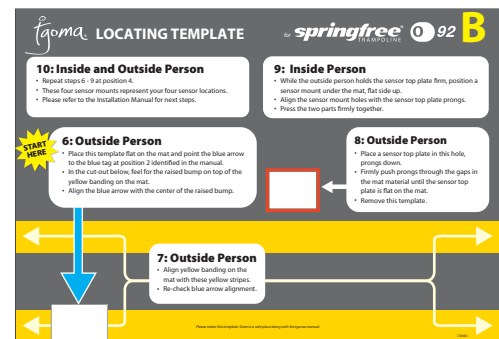
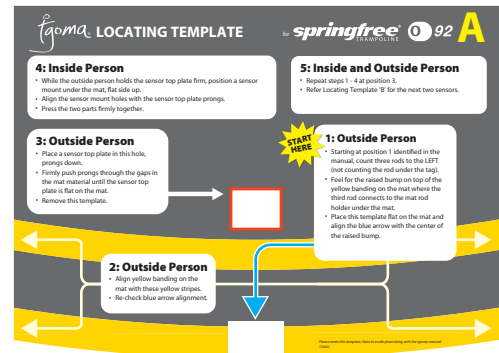
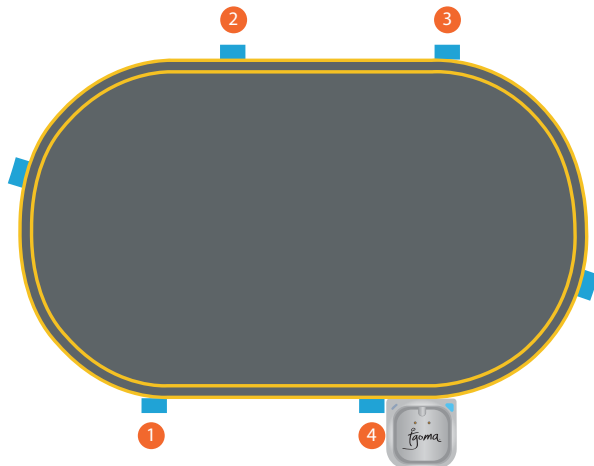

WARNING - Treat any loaded rod with caution until you are sure it is properly installed or uninstalled. Keep your face well away from any loaded rod.

- **Outside Person:** Locate the blue tags on the mat as shown.
- **Outside Person:** Wipe the surface of the mat around the blue tags with a clean, dry cloth so that it is clear of debris.
- **Inside and Outside Person:** Starting at the first blue tag position shown above, follow the steps on the locating template to install the sensor mounts and top plates. Be sure to start on template A and find the "START HERE" icon for the first step.

BOTTOM VIEW BEFORE

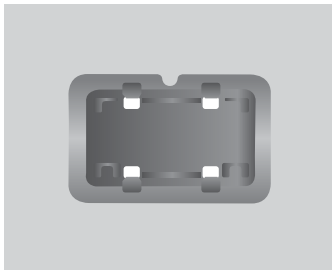

TOP VIEW BEFORE



BOTTOM VIEW AFTER

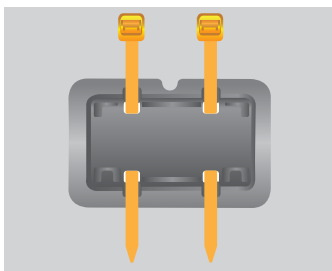

TOP VIEW AFTER



WARNING - Treat any loaded rod with caution until you are sure it is properly installed or uninstalled. Keep your face well away from any loaded rod.



NOTE - Be sure not to fasten the small cable ties during this step.

- **Inside Person:** Feed a small cable tie up through one of the holes in the sensor mount.
- **Outside Person:** Pull the cable tie across the channel and down through the corresponding hole. DO NOT fasten the cable ties, this will be done later.
- **Inside and Outside Person:** Repeat for the other end of the sensor mount and for the remaining three sensor positions.

OUTSIDE VIEW

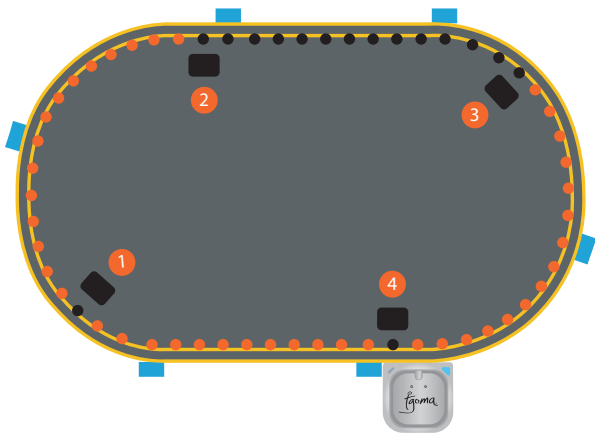

INSIDE VIEW

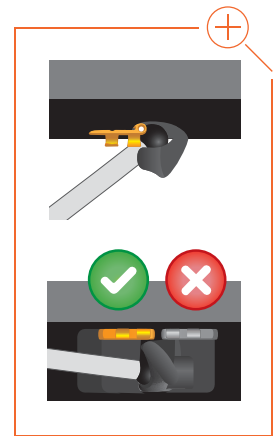
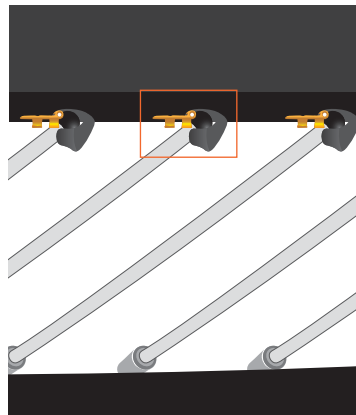

WARNING - Treat any loaded rod with caution until you are sure it is properly installed or uninstalled. Keep your face well away from any loaded rod.

- **Inside Person:** Starting at sensor position 2, locate the first mat rod holder to the left. Install a cable clip at the front of the mat rod holder pocket, as shown.
- **Inside Person:** Moving to the left around the trampoline, install ONE cable clip in front of each mat rod holder pocket between sensor positions 2 and 1. Do not install a cable clip in front of any of the sensor positions.
- **Inside Person:** Repeat this process from sensor positions 1 to 4 and 4 to 3.

OUTSIDE VIEW

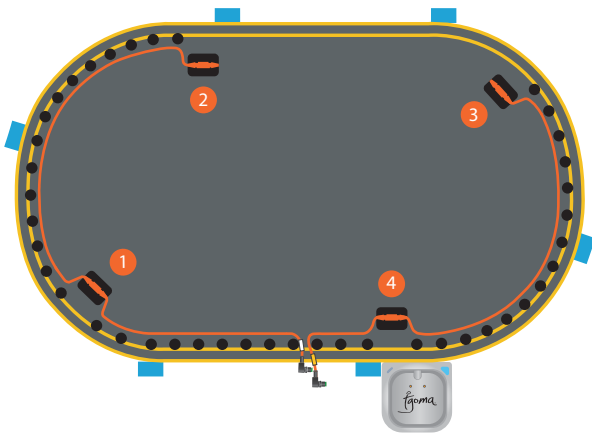

INSIDE VIEW

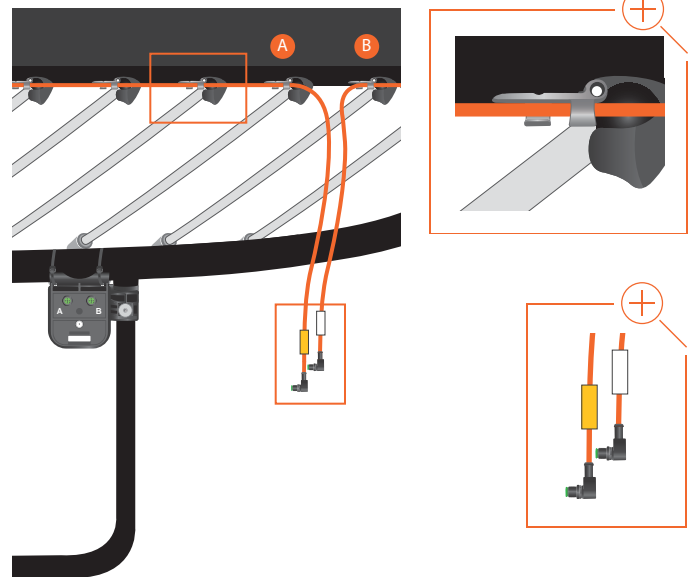

BOTTOM VIEW BEFORE

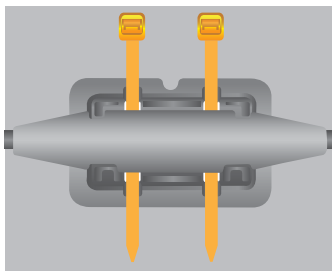

BOTTOM VIEW AFTER

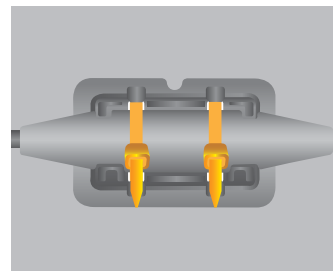

NOTE - Before proceeding, double check that each cable clip is pushed fully onto the edge of its pocket and that there are no cable clips installed in front of any of the sensor positions.



TIP - If you are having trouble inserting the cable sensors into the sensor mounts, try flipping them over. They are designed to only fit one way.

- **Inside Person:** Before installing the cables, note that they are different lengths and have different color labels.
- **Inside Person:** Starting at sensor position 2, take the cable with the white tag and install the end cable sensor into the sensor mount. Once it is in place, fasten the cable ties as shown.
- **Inside Person:** Then, working towards sensor position 1, install the cable into each cable clip, as shown.
- **Inside Person:** At sensor position 1, install the middle cable sensor into the sensor mount and fasten the cable ties. If the middle cable sensor does not align with the sensor mount, double check that you have the correct cable and that the sensor mounts are installed in the correct positions relative to the blue tags.
- **Inside Person:** Continue installing the cable into the cable clips until you reach position B as shown above. Leave the end of the cable hanging down towards the controller.
- **Inside Person:** Starting at sensor position 3, take the cable with the yellow tag and repeat the above process to sensor position 4 and then to position A. Be sure to fasten the cable ties at each sensor. At position A, the end of the cable should be hanging down towards the controller.

OUTSIDE VIEW

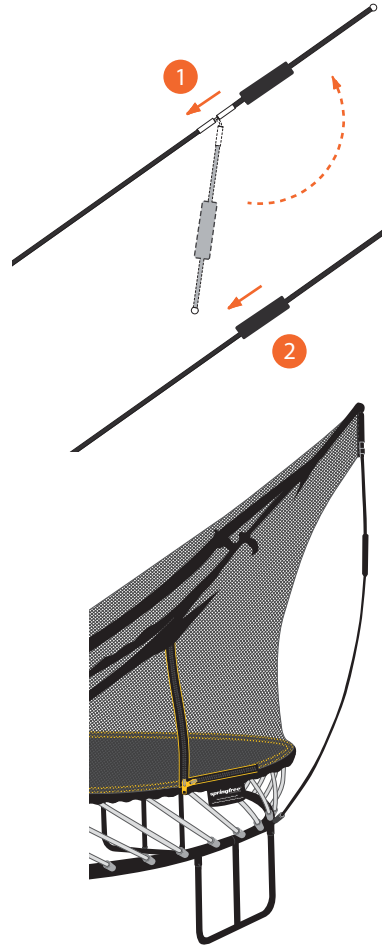
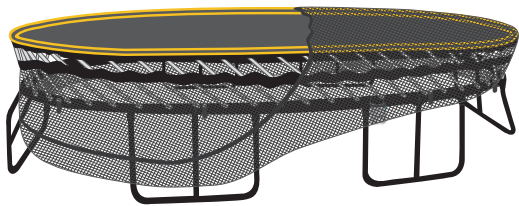
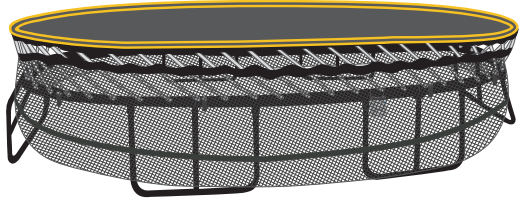
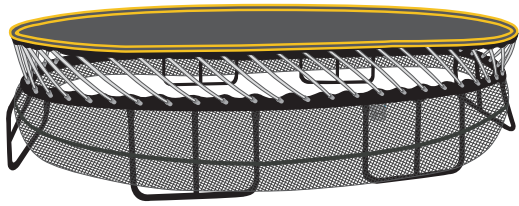

WARNING - Treat any loaded rod with caution until you are sure it is properly installed or uninstalled. Keep your face well away from any loaded rod.
WARNING - Never attempt to remove a black net rod from its net rod pocket or disengage (unlock) the rod sleeve while the black net rod is under tension.



NOTE - Refer to step 8, 9, and 10 in the Trampoline & Enclosure Assembly Instructions for more information.

- **Outside Person:** Starting at a corner, carefully pull the net up over the edge of the mat. It is normal for the net to be tight.
- **Outside Person:** Working around the frame, lift the rest of the net into the center of the mat. Ensure that the bottom band of the net is pulled all the way to the top of the white mat rods.
- **Outside Person:** Re-assemble the black net rods as shown.
- **Outside Person:** Insert ALL of the black net rods into the net rod pockets at the top edge of the net. Push the rod up into the pocket and past the catch. You will feel some resistance as the ball is pushed through.
- **Outside Person:** Ensure all of the C-clips are installed and fully seated.
- **Outside Person:** Insert the bottom end of the black net rod into the net rod socket on the trampoline frame. You will hear a click when the black net rod is fully seated.

INSIDE VIEW

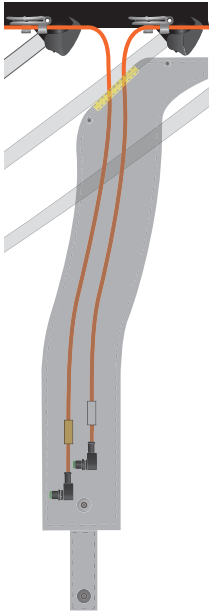

INSIDE VIEW

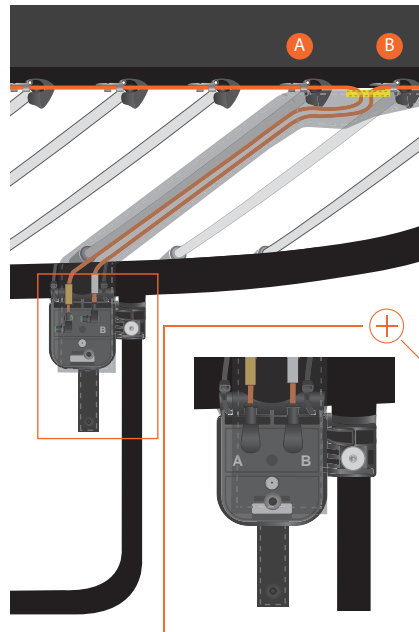

INSIDE VIEW

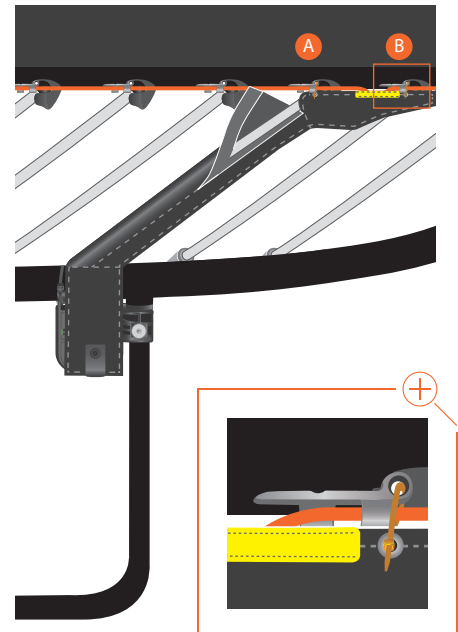

NOTE - Cable A with the yellow tag must be plugged into socket A and cable B with the white tag into socket B. The cable plugs and controller sockets are 'keyed' (ie, they will only fit correctly in one position). Line up the green post in the cable plug with the slot in the controller socket. Do not force the plug into the socket; when you have correctly keyed them they will slide together easily.

- **Inside Person:** Locate the ends of the cables that are hanging down at cable clip A and B. Cable A should be on the left and have the yellow tag. Cable B should be on the right and have the white tag.
- **Inside Person:** Next, locate the yellow strip along the top edge of the sensor cable tube. At the yellow strip, feed cable A through the top of the tube until it comes out the end.
- **Inside Person:** Repeat with cable B. When the end of the cable comes out the end of the tube, plug it into socket B on the back of the controller and tighten the collar. Then, plug the end of cable A into socket A and tighten.
- **Inside Person:** Undo the Velcro® strip on the sensor cable tube, wrap it around the mat rod, and refasten, as shown.
- **Inside Person:** Next, locate the eyelets beside the yellow strip along the top edge of the sensor cable tube. Pass a small cable tie through an eyelet and the corresponding hole in the cable clip, as shown, then fasten. Repeat for both eyelets.
- **Inside Person:** Fasten the strap at the bottom of the sensor cable tube through the back of the controller.
- **Inside and Outside Person:** The remaining steps can be completed by just one person.



WARNING - If there is any excess cable, loop it and tuck it back up into the sensor cable tube.

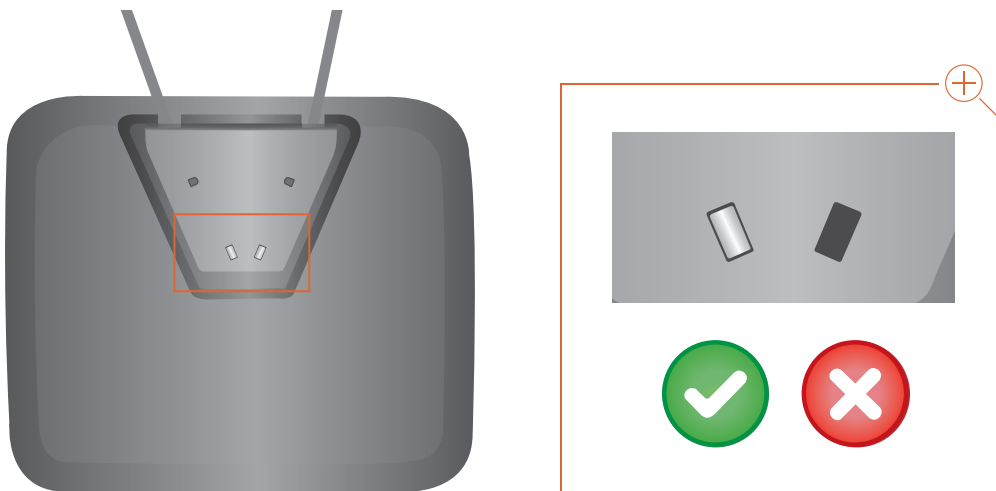
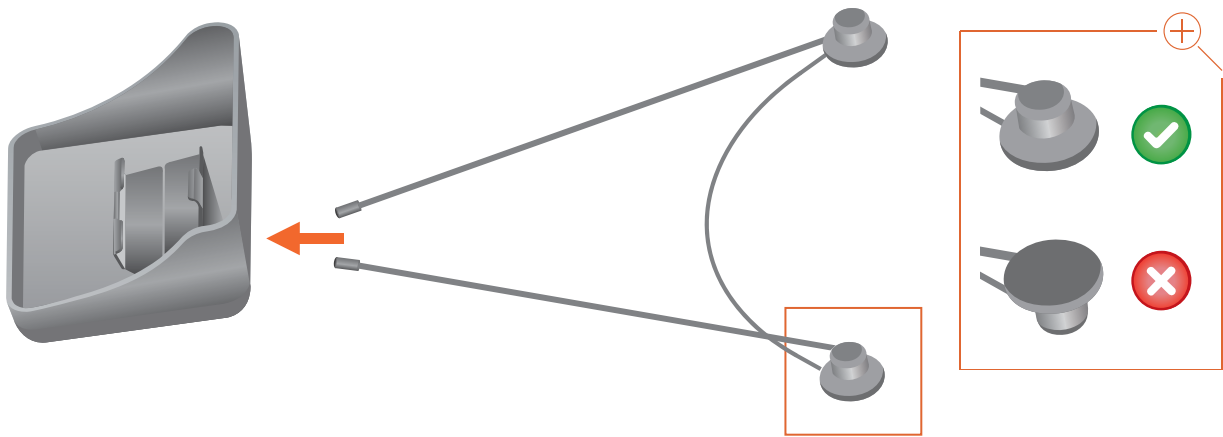

WARNING - Treat any loaded rod with caution until you are sure it is properly installed or uninstalled. Keep your face well away from any loaded rod.



NOTE - Ensure the tablet holder is in the correct orientation.



TIP - The software's default position for the tablet holder is opposite the door. Consult your Software User Guide for how to position the tablet holder in alternative locations.

TIP - If you accidentally install the rods with the incorrect orientation, push a key into each slot on the back of the plastic part of the tablet shade and pull the rods free.

- Orient your tablet holder rods relative to the tablet holder, as shown.
- Insert the rods into the back of the tablet holder. When assembled, the rods will click into place. When fully inserted, you should be able to see the ends of the rods through the slots and the rods will not easily come loose.

Minimum Tablet Specifications

Apple® Tablets:

- iPad 3 or more recent, iPad Mini & iPad Air.
- Bluetooth® 4 (also known as LE) or more recent
(NOTE: iPads 1 and 2 cannot be used because they do not have Bluetooth 4).
- Tablets with screen size between 7” and 11” (not phones).

Android™ Tablets:

- Android operating system 4.4 or more recent.
- Bluetooth 4 (also known as LE) or more recent.
- Tablets with screen size between 7” and 11” (not phones).



NOTE - tgoma Software is designed to operate on tablets with the minimum specifications listed above. If you are trying to use tgoma on any device outside of these specs tgoma will not work correctly. Note: Windows tablets are not supported.

NOTE - We recommend you read the full Software User Guide, which can be downloaded from www.tgoma.com/support.



TIP - When searching for the tgoma app on iTunes® Store or Google Play™, look for this icon:



- Ensure your tablet is connected to WiFi.
- If using an Apple tablet, go to iTunes Store and search ‘tgoma’.
- If using an Android tablet, go to Google Play and search ‘tgoma’.
- Follow on-screen instructions to download and install tgoma. The tgoma icon will appear in the tablet’s app list. Tap to open.

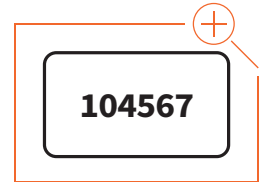

NOTE - Ensure your tablet is connected to WiFi while you are setting it up.

NOTE - Once set up you do not need a WiFi signal to use tgoma.

NOTE - Ensure you complete all of the Set Up steps. It is important you have selected both the correct trampoline model and position for your tablet (these are steps in the Set Up process).

- Get started with tgoma by setting up your account. Although it is possible to use tgoma as a Guest, to access games and the full range of features tgoma offers, you will need to create a Family Account.
- Use a password you will remember. This will be asked for when downloading new games.
- Enter the serial number from the sticker attached to your Installation Manual (or tgoma packaging) – this will help our customer care team assist you should you need it.
- Follow Set-Up steps on-screen.

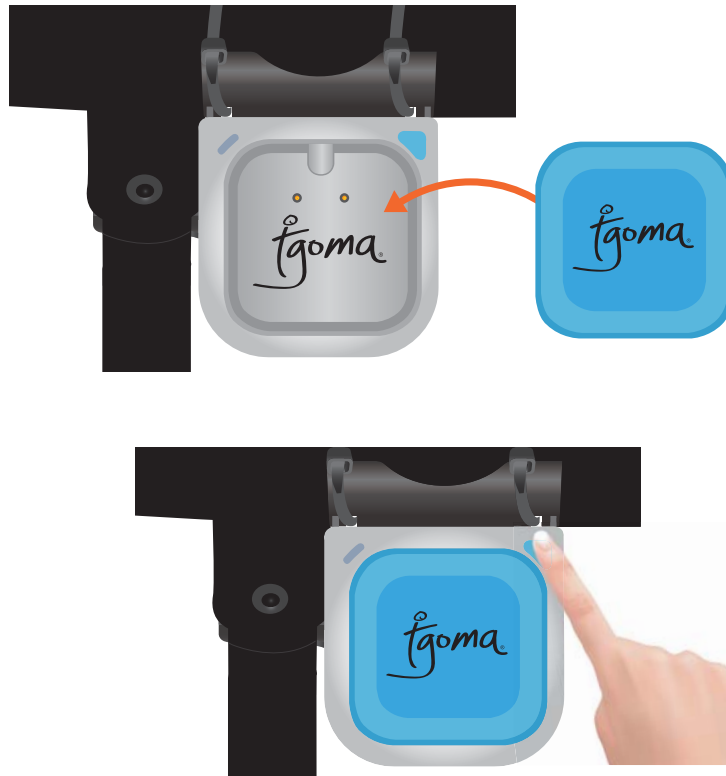

WARNING - To protect the batteries store the battery pack indoors when not in use.



NOTE - When you turn the controller on to connect to your tablet, ensure there is nobody standing/sitting on, or leaning against, the trampoline for 15 seconds. This allows the controller to correctly set the sensors for accuracy. This wait time should be observed each time after the trampoline is moved.



TIP - tgoma is designed to work across a wide range of tablets. Not all versions of Android connect to Bluetooth in the same way. Your tablet should automatically connect to a tgoma controller when you start the tgoma app and turn the controller on. If the **BLUE** light on the controller does not light up after approximately 30 seconds, you may need to power off the tablet and restart it. This should allow the Bluetooth connection to be established.

- Ensure your tablet has Bluetooth turned on. Take the tablet out to your trampoline.
- Install 4 AA batteries into the battery pack and place the battery pack on the controller.
- Make sure nobody is on or leaning against the trampoline.
- Turn on the controller by pressing the button on the front and wait for it to connect to your tablet.
- The **GREEN** light should now be pulsing, indicating that the controller is running. Please wait for at least 15 seconds to allow the system to calibrate the sensors before touching the trampoline.
- Start the tgoma app on your tablet. After a few seconds the **BLUE** light should begin pulsing, indicating that the Bluetooth connection is established.





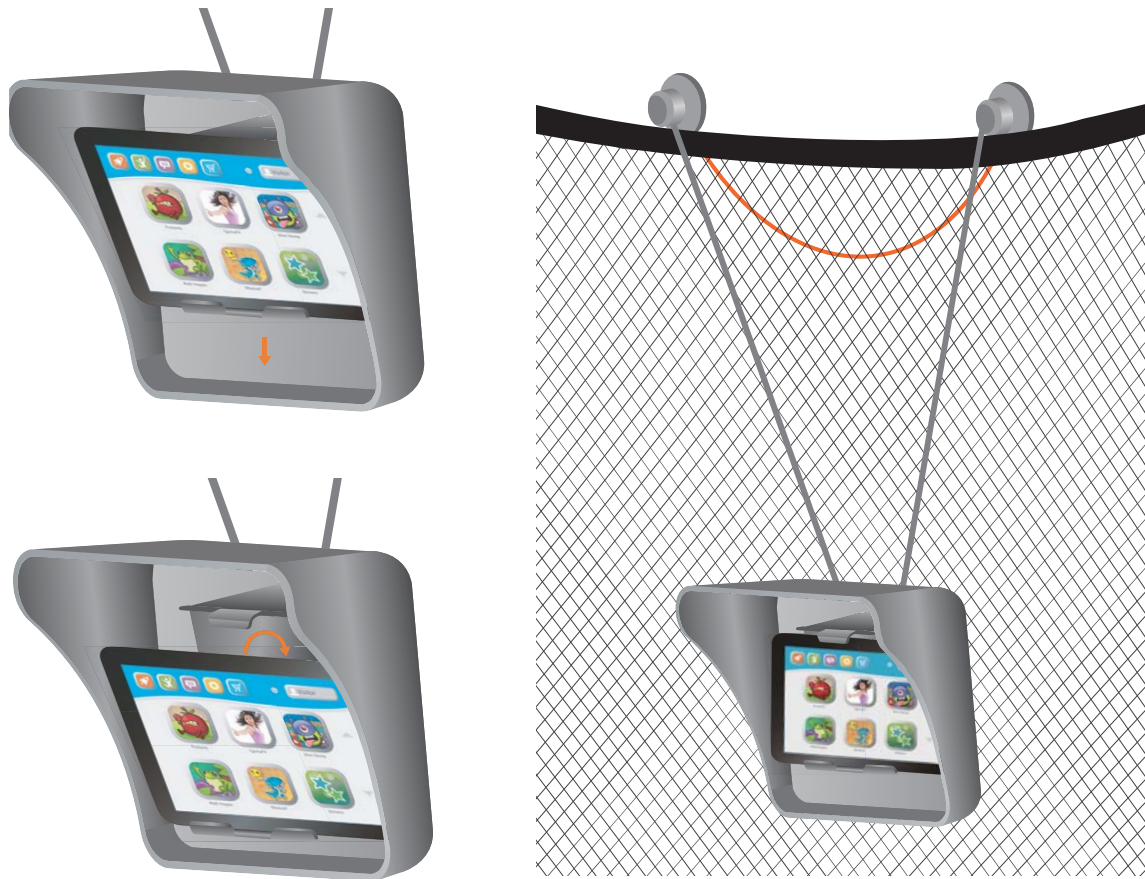



NOTE - The **RED** light will begin pulsing if there is an error with the system. The error will be described underneath Tech Info on the General Settings page of the tgoma app.



WARNING - Do not leave your tablet outside in wet weather.

- Once you have completed setting up your tgoma on your tablet, hold your tablet in a landscape orientation and place the bottom edge onto the bottom jaw of the clamp.
- Pull the tablet down on the bottom jaw until the clamp opens wide enough for the tablet to fit between the top and bottom jaws of the clamp.
- Push the tablet back into position, and release.
- Hook the tablet holder onto the inside of the trampoline net, opposite the entrance.



 <p>Games: where your games and apps live once you've downloaded them.</p>	 <p>JumpFit: where you access your jump stats via the JumpTracker, or set goals to achieve.</p>	 <p>News & Events: where you see news and events to participate in.</p>
 <p>Settings: where you set up tgoma (make sure you select your trampoline model in General Settings before using it).</p>	 <p>Store: where you preview all the games and apps available. New games are added frequently so check this area regularly.</p>	 <p>Users: tap this to create a new user. Accurately setting the user weight will allow tgoma to more accurately calculate your energy burn rate. Once users are set up they can compete in competitions and events, and track their activity in the JumpTracker.</p>

NOTE - If you need to disassemble your tgoma game system or your trampoline, please go to www.tgoma.com/support for detailed instructions.



NOTE - If you are experiencing any issues, or if you have any questions regarding the installation or performance of your tgoma gaming system, please go to www.tgoma.com/support.

NOTE - When the tgoma controller is powered on it will broadcast its availability to any tablets within an approximate range of 160 ft (50 m). Any tablet running the tgoma application can connect to the controller. Where multiple tablets have the tgoma app installed, close the tgoma app on all tablets except the one being used on the trampoline. This will stop unintended Bluetooth connections occurring.

- Explore tgoma by tapping through the buttons in the menu bar shown above.
- Congratulations! You have successfully installed your tgoma game system! Happy bouncing!

PRODUCT SPECIFICATION TABLE

Name of product as described in the marketing literature	tgoma Game System
Part number(s)	TGR54000, TGR79000, TGO77000, TGO92000, TGS113000, TGS155000
Operating temperature range	0°C to +40°C (+32°F to +104°F)
Storage temperature range	0°C to +40°C (+32°F to +104°F)
Operating humidity	10% to 90% non-condensing
RF Compliances	FCC class B; IC class B; EN/CE class B
Safety agency approvals	TBD but UL60950 etc.
Power	4 x user supplied AA (alkaline preferred) batteries

The tgoma game controller and sensor cables are UL listed under file E481698

tgoma is a registered trademark of tgoma NZ Ltd.

The Bluetooth® word, trademark and logos are owned by the Bluetooth SIG, Inc. and any use of such marks is under license. Android™, Google Play™ and the Google Play logo are trademarks of Google Inc. Apple iTunes® and iPad™ are registered trademarks of Apple Inc. Other trademarks and trade names are those of their respective owners.

Patents pending.

All rights reserved. No part of this publication may be reproduced, stored in a retrieval system, or transmitted, in any form or by any means, without the prior written permission from tgoma NZ Ltd.

tgoma NZ Ltd reserves the right to make changes at any time without notification. While every care has been exercised in compiling and publishing the information contained in these pages, tgoma NZ Ltd accepts no responsibility for errors or omissions to the information.

FCC RF Radiation Exposure Statement:

Contains Transmitter Module FCC ID: QOQBLE113

This equipment complies with part 15 of the FCC radiation exposure limits set forth for an uncontrolled environment. End users must follow the specific operating instructions for satisfying RF exposure compliance. This transmitter meets both portable and mobile limits as demonstrated in the RF Exposure Analysis. This transmitter must not be co-located or operating in conjunction with any other antenna or transmitter except in accordance with FCC multi-transmitter product procedures.

Déclaration d’IC:

Contient module émetteur IC: 5123A-BGTBLE113

Cet appareil ISM est conforme à la norme NMB-001 du Canada

Ce dispositif est conforme aux normes RSS exemptes de licence d’Industrie Canada. Son fonctionnement est assujetti aux deux conditions suivantes: (1) ce dispositif ne doit pas provoquer de perturbation et (2) ce dispositif doit accepter toute perturbation, y compris les perturbations qui peuvent entraîner un fonctionnement non désiré du dispositif.

IC Statements:

Contains Transmitter Module IC: 5123A-BGTBLE113

This ISM device complies with Canadian ICES-001.

This device complies with Industry Canada license-exempt RSS standard(s). Operation is subject to the following two conditions: (1) this device may not cause interference, and (2) this device must accept any interference, including interference that may cause undesired operation of the device.

Contains Transmitter Module FCC ID: QOQBLE113
 Contient module émetteur IC: 5123A-BGTBLE113
 Contains Transmitter Module IC: 5123A-BGTBLE1



tgoma® Game System Limited Warranty

DO NOT USE YOUR PRODUCT UNTIL YOU HAVE READ THE TERMS OF THE WARRANTY. IF YOU DO NOT AGREE TO THE TERMS OF THE WARRANTY, DO NOT USE THE PRODUCT AND RETURN IT WITHIN 7 DAYS TO THE STORE OR THE AUTHORIZED DISTRIBUTOR WHERE YOU PURCHASED IT FOR A REFUND.

WHAT IS COVERED

tgoma NZ Ltd. and its authorized service partners warrant this product against original defects in material and workmanship for a period of ONE (1) YEAR. The warranty period begins from the date of purchase (proof of purchase required). This warranty is only valid when used for private household purposes in accordance with the tgoma® Assembly Instructions. This warranty provides, at no extra cost to you, all parts necessary to ensure your accessory is in proper working condition throughout the warranty period. For information related to the warranty and tgoma software, check www.springfree.com/tgoma.

WHAT IS NOT COVERED

This warranty is subject to the following terms:

- tgoma NZ Ltd. shall not be liable for costs, damages or repairs incurred as a result of:
 - Product purchased from an unauthorized distributor.
 - Improper installation not in accordance with the provided tgoma Assembly Instructions.
 - Careless operation or handling, accident, abuse, misuse and/or lack of maintenance not in accordance with the tgoma Assembly Instructions.
 - External sources such as weather, theft, fire damage, cuts or vandalism.
 - Damage caused by repairs carried out by unauthorized parties or agents.
 - Damage resulting from opening the controller box and tampering with the hardware.
 - Use other than for private household purposes. For example, for commercial or rental purposes.
- This warranty does not apply to consumable parts, such as batteries or protective coatings that are designed to diminish over time, unless failure has occurred due to a defect in materials or workmanship.
- This warranty does not apply to cosmetic damage or minor imperfections that meet design specifications or do not materially alter functionality.
- This warranty does not cover expenses related to on-site labor, travel, assembly or disassembly or other charges associated with the repair or replacement of covered components.
- This warranty does not apply to any non-tgoma products or any software.

SUBMITTING YOUR WARRANTY CLAIM

If you believe your product has a manufacturing fault or a product defect and you need to make a warranty claim, locate and contact your nearest tgoma customer service center at www.tgoma.com/support. Alternatively, you can lodge your warranty claim online at <http://springfr.ee/wclaim>.

The terms of the warranty require that you contact tgoma NZ Ltd. with your model name, serial number, date and place of purchase and a scan of your purchase receipt. Shipping costs associated with approved warranty claims lodged within 45 days from the date of purchase will be covered by tgoma NZ Ltd. Beyond this 45-day period, all shipping costs are the responsibility of the customer. Replacement parts provided under this warranty do not extend the period of the warranty.

WARRANTY LIMITATIONS

- tgoma NZ Ltd. is not responsible or liable for indirect, special or consequential damages arising out of or in connection with the use or performance of the product or any other damages with respect to any economic loss, loss of property, loss of revenue or profits, loss of enjoyment or use, cost of removal, installation, disassembly or other consequential damages. This limitation is not allowed by some states, provinces or territories and so this limitation may not apply to you.
- tgoma NZ Ltd. will not be liable for any consequential damages or incidental damages you may incur in connection with the tgoma game system, any portable electronic devices (tablet, phone, etc.) or trampoline or accessories. This limitation is not allowed by some states, provinces, or territories and so this limitation may not apply to you.
- Any implied warranties relating to your product, including but not limited to warranty of merchantability or warranty of fitness for a particular purpose, are to the duration of this warranty. This limitation is not allowed by some states, provinces or territories and so this limitation may not apply to you.
- This warranty gives you specific legal rights. You may also have other rights which vary by state, province or territory.
- For customers in Australia, our goods come with guarantees that cannot be excluded under the Australian Consumer Law. You are entitled to a replacement or refund for a major failure and compensation for any other reasonably foreseeable loss or damage. You are also entitled to have the goods repaired or replaced if the goods fail to be of acceptable quality and the failure does not amount to a major failure.
- This warranty is not transferable and applies only to the consumer who originally purchased the accessory.
- This warranty does not extend to any portable electronic devices (tablet, phone, etc.) or trampoline or accessories.

If you have any questions or concerns regarding this warranty, locate and contact your nearest tgoma customer service center at www.tgoma.com/support. If you need replacement parts but your warranty has expired, you can purchase them by contacting your nearest tgoma customer service center.