

Model 223 / Model 234 / Model 238



TITAN[®]

Sport für viele Jahre







Rectangular Trampolines

Assembly manual







Model 223 / Model 234 / Model 238



Model 238
APPROX 380x255cm

Quantity	Part number	
Jumping mat	1	TEPL-238-222 
Galvanized spring L=215mm Ø3.2mm	90	TEPL-200-211/A 
Galvanized spring L=175mm Ø3.2mm	4	TEPL-200-211/C 
Safety pad	1	TEPL-238-333-grey or AVGR-238-333-green or CAM-238-333-camouflage 
Fastener for Safety pad	8	TEPL-ELAS-A 
V-tube	4	TEPL-238-116 A 
U-tube	2	TEPL-238-1142 

Model 238
APPROX 380x255cm

Quantity	Part number	
K-tube	2	TEPL-238-1141 
Screw M8, nut and washer	8	M8-70 
Wrench	2	WRENCH 
Fastener for Safety pad	20	TEPL-ELAS-B 
Tool for springs	1	TOOL-SPRING 
Safety Manual	1	208010301
Users Manual	1	208010101
Warning Card	1	208040101
Tie rip for warning card	1	209010102
J-tube	8	TEPL-238-116 B 
Screw M8, nut and washer	8	M8 - 60 

1.

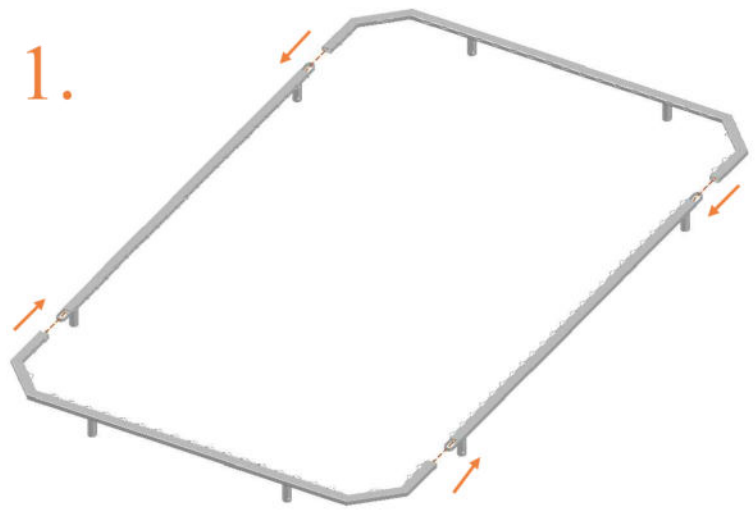

2.

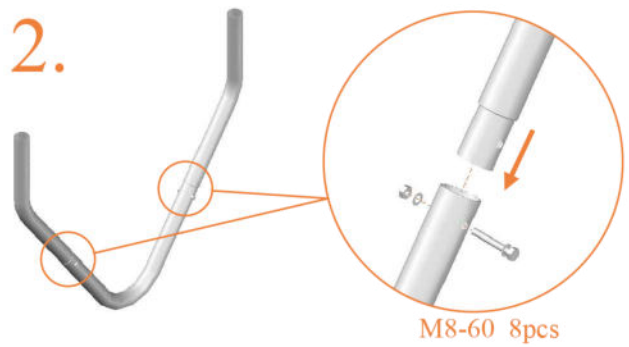

M8-60 8pcs

3.

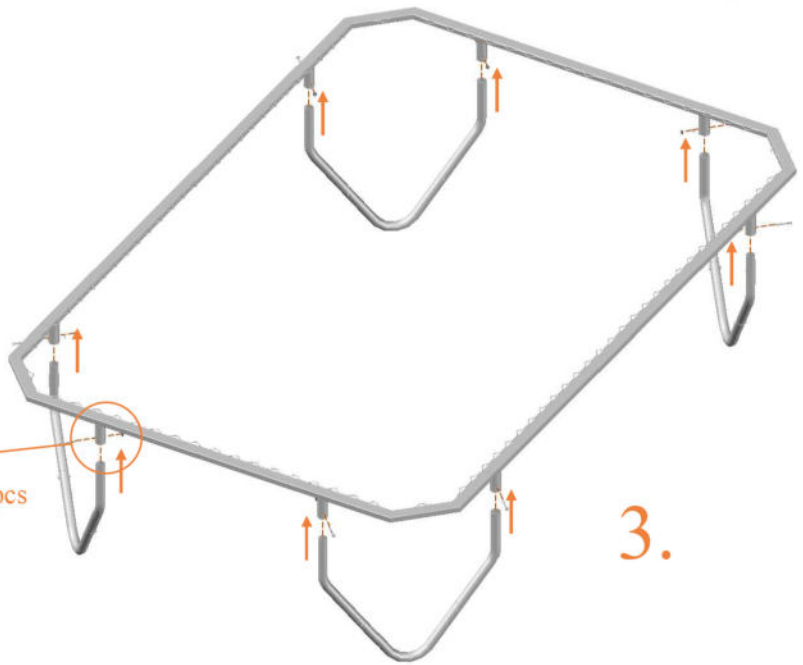

M8-70 8pcs

4. 234/238: 8x spring 215mm
223 : 8x spring 175mm



5. 234/238: 78/90x spring 215mm
223: 66x spring 175mm

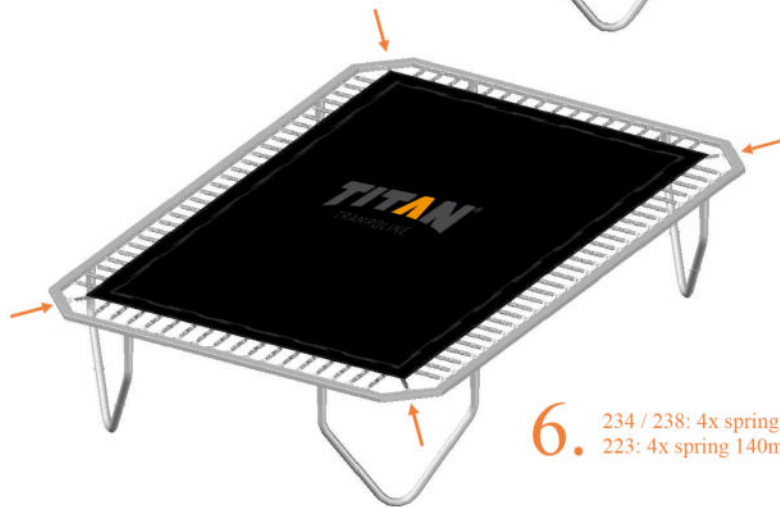
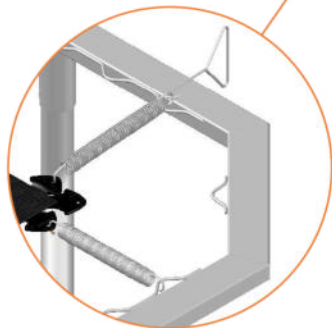
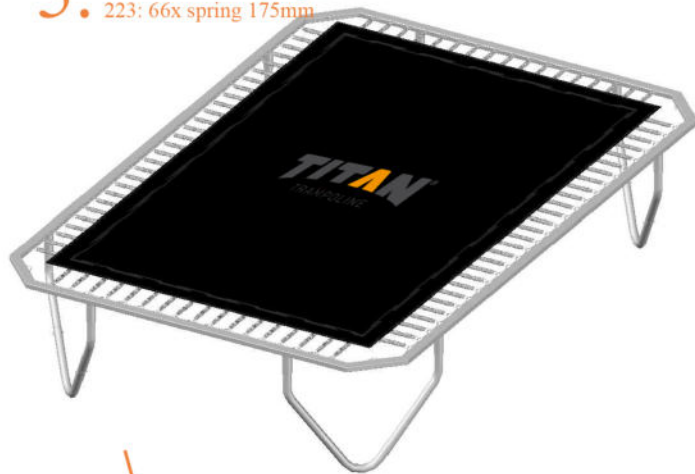

6. 234 / 238: 4x spring 175mm
223: 4x spring 140mm

7.



TEPL-ELAS-B



TEPL-ELAS-A
234 / 238: 12x
223: 8x

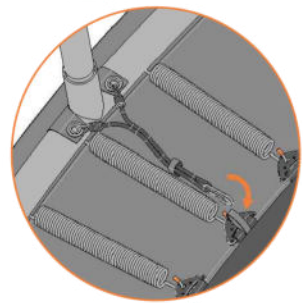



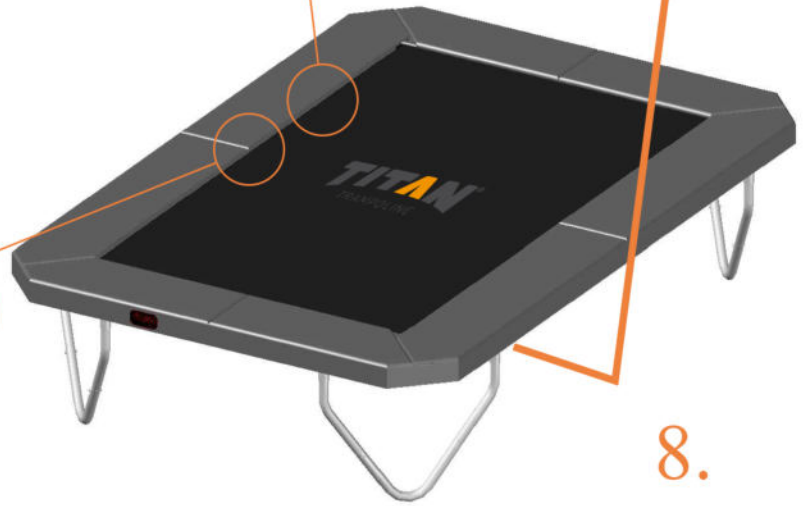
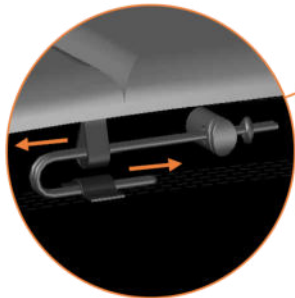
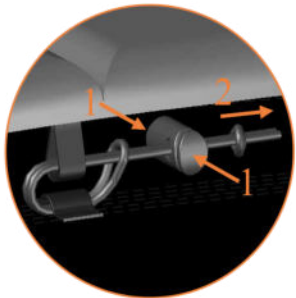





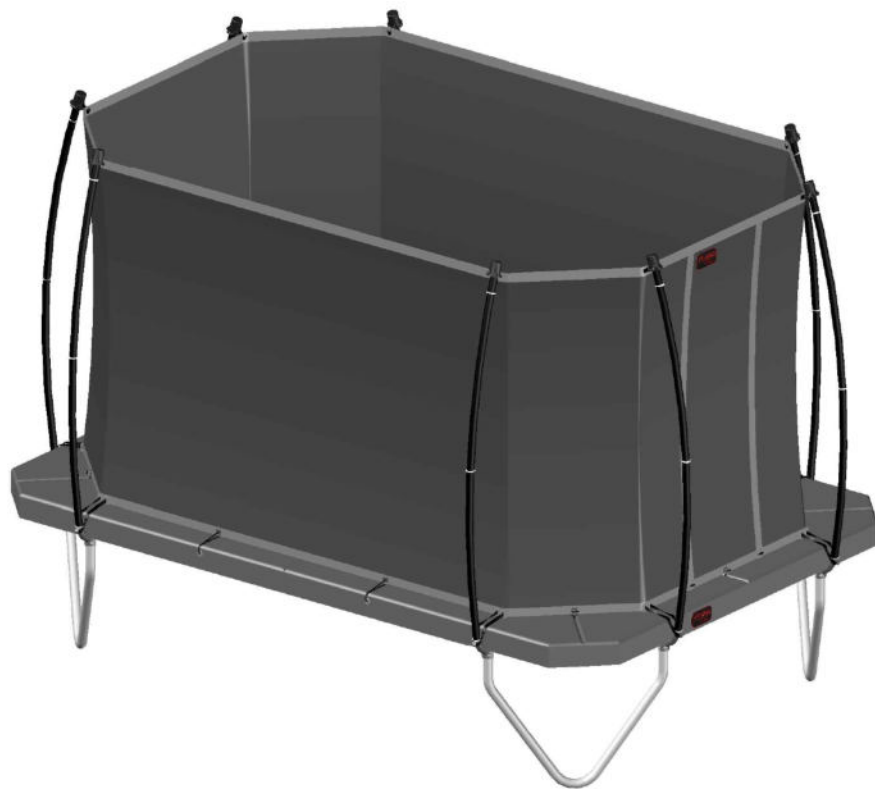



TEPL-ELAS-B



8.

Model 223 / Model 234 / Model 238



		Model 223 APPROX 305x225cm		Model 234 APPROX 340x240cm		Model 238 APPROX 380x255cm	
		Quantity	Part number	Quantity	Part number	Quantity	Part number
Pole with sleeve for safety net		8	AVBL-223-802 A	8	AVBL-234-802 A	8	AVBL-238-802 A
Pole for safety net		8	AVBL-223-802 B	8	AVBL-234-802 B	8	AVBL-238-802 B
Clamp		8	CLAMP-TOOL-SN-223	8	CLAMP-TOOL-SN-234	8	CLAMP-TOOL-SN-238
Safety net		1	TEGR-223-green or ANGR-223-grey	1	TEGR-234-green or ANGR-234-grey	1	TEGR-238-green or ANGR-238-grey
Straps for safety net		16	TEPL-BAND	16	TEPL-BAND	16	TEPL-BAND
Closure for safety net		2	TEPL-KNOOPJE	2	TEPL-KNOOPJE	2	TEPL-KNOOPJE
Screw M6		8	M6-30	8	M6-30	8	M6-30
Screw M8		16	M8-25	16	M8-25	16	M8-25
Allen key		2	ALLEN-KEY	2	ALLEN-KEY	2	ALLEN-KEY
Wrench		2	WRENCH	2	WRENCH	2	WRENCH
Closure for safety net		8	TEPL-ELAS-C	10	TEPL-ELAS-C	10	TEPL-ELAS-C

1.

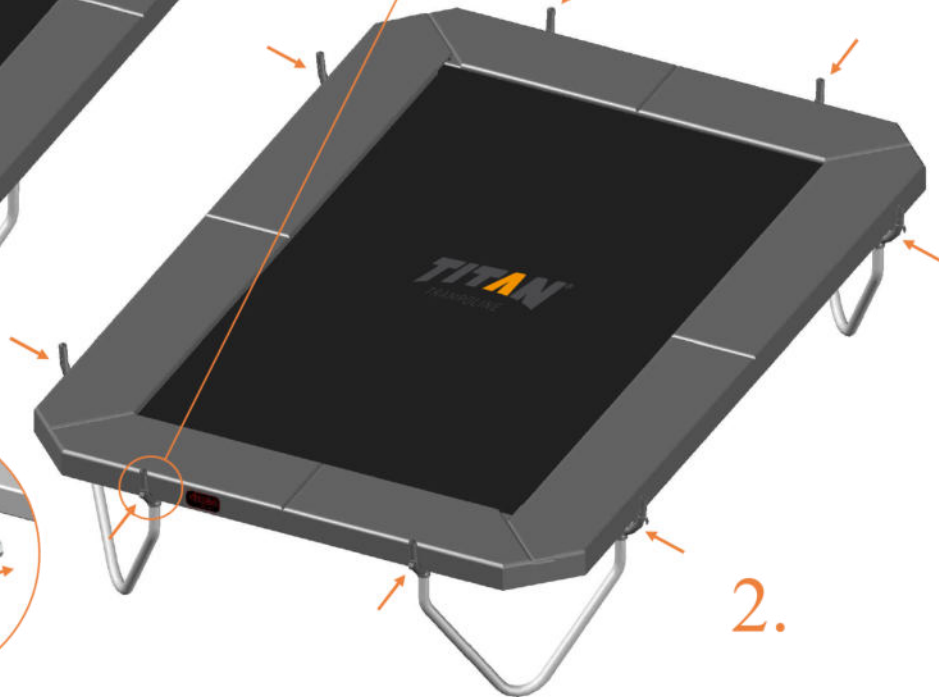
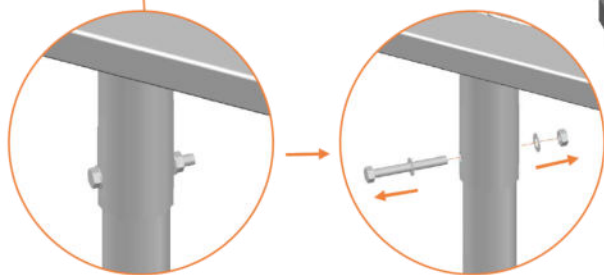
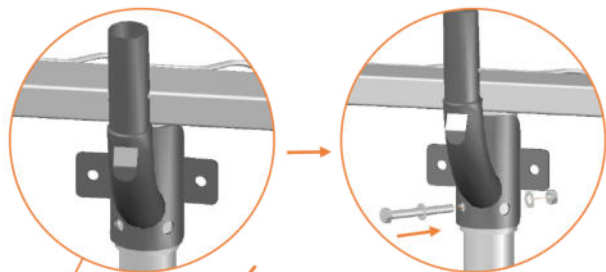

2.

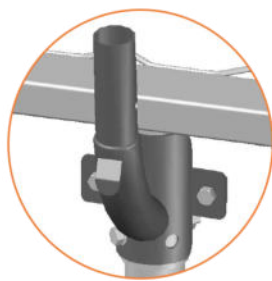
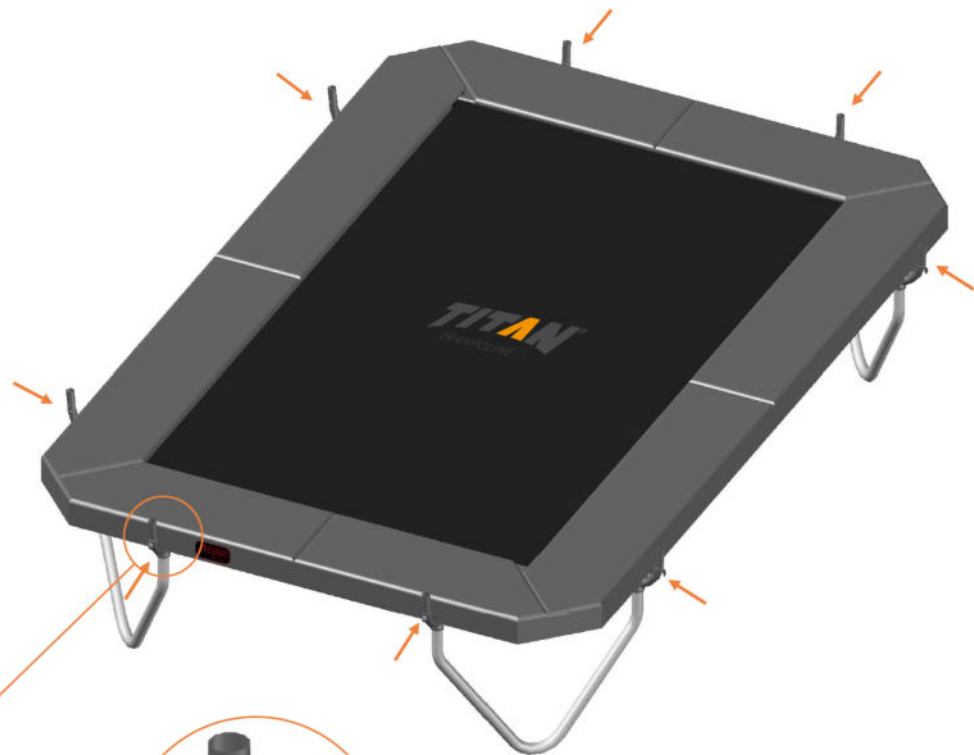

3.

4.

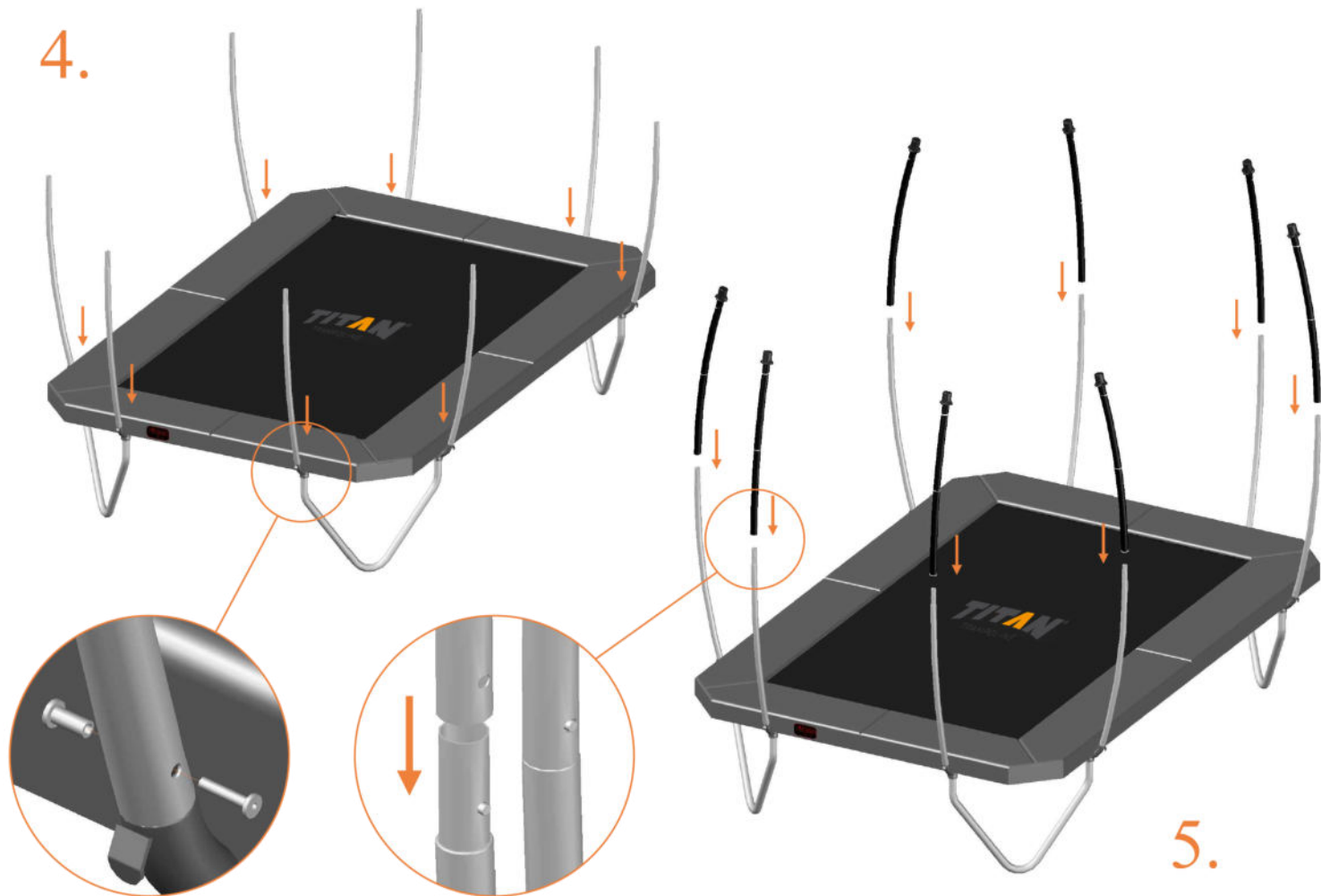

5.

6.



7.

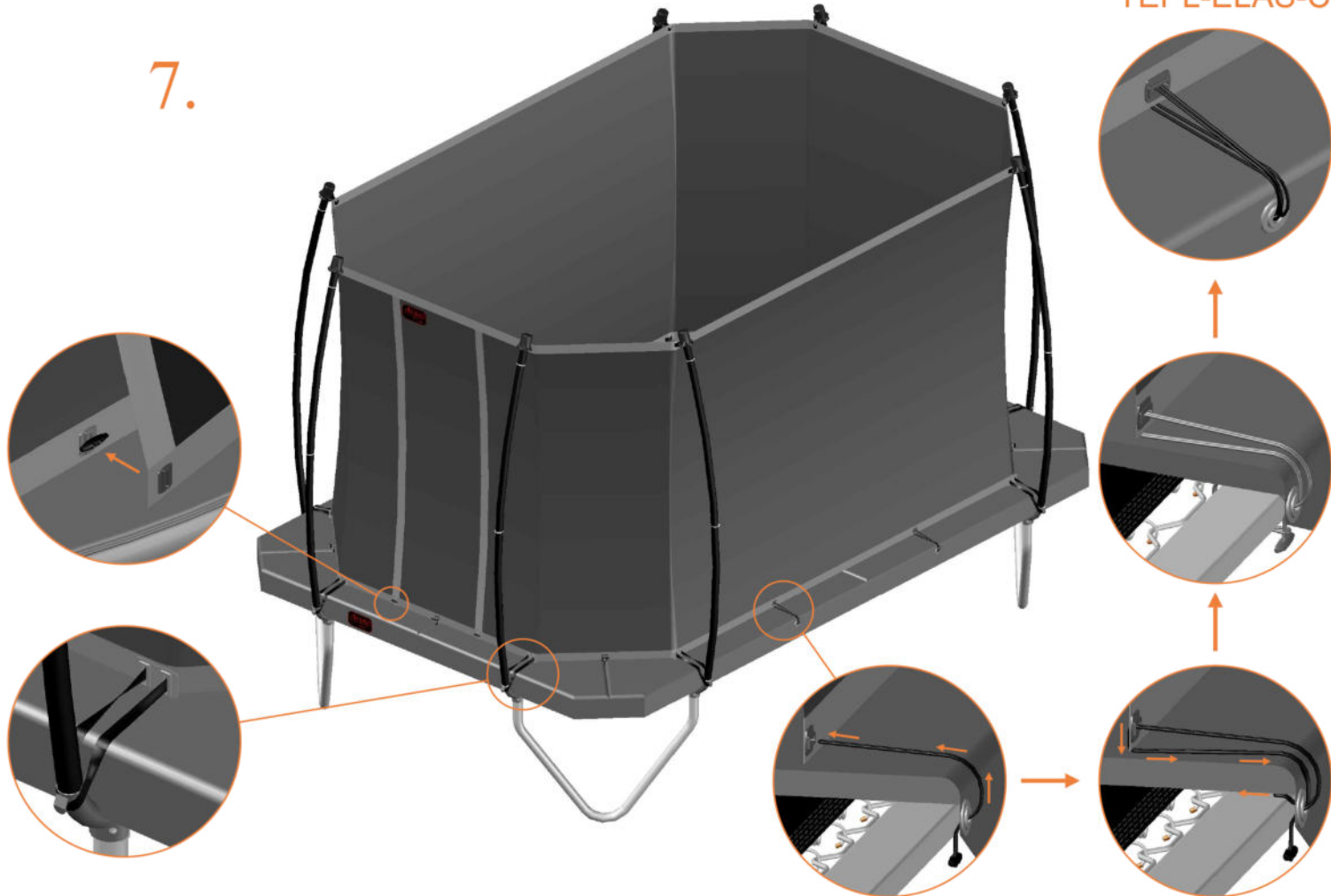

TEPL-ELAS-C

Model 213
213/010

Model 213 / Model 214 / Model 215
300x225 / 300x240 / 300x255

Model 202
202/005



Sales office: Beneluxbaan 7
5121 DC Rijen
The Netherlands
sales@avyna.eu
www.avyna.eu